

MISP USER TRAINING - GENERAL USAGE OF MISP

MISP - THREAT SHARING

CIRCL / TEAM MISP PROJECT

[HTTP://WWW.MISP-PROJECT.ORG/](http://www.misp-project.org/)
TWITTER: @MISPPROJECT

CIISI-IE DUBLIN 2024



2024-07-08

MISP User Training - General usage of MISP

MISP USER TRAINING - GENERAL USAGE OF MISP

MISP - THREAT SHARING

CIRCL / TEAM MISP PROJECT

[HTTP://WWW.MISP-PROJECT.ORG/](http://www.misp-project.org/)
TWITTER: @MISPPROJECT

CIISI-IE DUBLIN 2024



■ Credentials

- ▶ MISP admin: admin@admin.test/admin
- ▶ SSH: misp/Password1234

■ Available at the following location (VirtualBox and VMWare):

- ▶ <https://www.circl.lu/misp-images/latest/>

└─ MISP - VM

- Credentials
 - ▶ MISP admin: admin@admin.test/admin
 - ▶ SSH: misp/Password1234
- Available at the following location (VirtualBox and VMWare):
 - ▶ <https://www.circl.lu/misp-images/latest/>

■ It is a bit broken.

- ▶ sudo -s
- ▶ cd /var/www/MISP/
- ▶ sudo pear install
INSTALL/dependencies/Console_CommandLine/package.xml
- ▶ sudo pear install
INSTALL/dependencies/Crypt_GPG/package.xml
- ▶ cd /usr/local/src/misp-modules
- ▶ pip3 install -r REQUIREMENTS
- ▶ pip3 install .
- ▶ reboot

└─ MISP - VM

- It is a bit broken.
 - ▶ sudo -s
 - ▶ cd /var/www/MISP/
 - ▶ sudo pear install
INSTALL/dependencies/Console_CommandLine/package.xml
 - ▶ sudo pear install
INSTALL/dependencies/Crypt_GPG/package.xml
 - ▶ cd /usr/local/src/misp-modules
 - ▶ pip3 install -r REQUIREMENTS
 - ▶ pip3 install .
 - ▶ reboot

Plan for this part of the training

- Data model
- Viewing data
- Creating data
- Co-operation
- Distribution
- Exports

2024-07-08

└─ MISP - General Usage

Plan for this part of the training

- Data model
- Viewing data
- Creating data
- Co-operation
- Distribution
- Exports

Event
Creator org
Description
Analysis
Threat level
Distribution

└─ MISP - Event (MISP's basic building block)



MISP - EVENT (ATTRIBUTES, GIVING MEANING TO EVENTS)

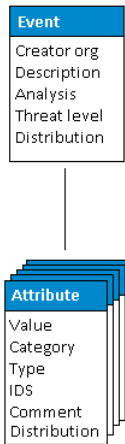

↳ MISP - Event (Attributes, giving meaning to events)



MISP - EVENT (CORRELATIONS ON SIMILAR ATTRIBUTES)

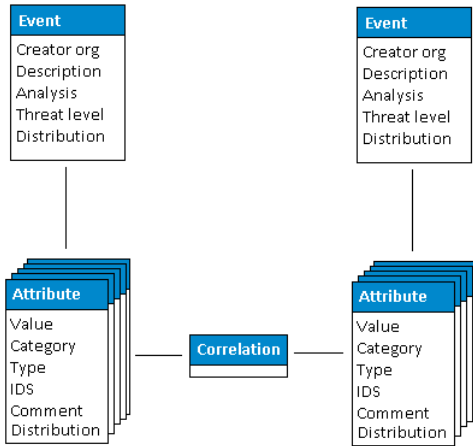

2024-07-08

MISP User Training - General usage of MISP

└─ MISP - Event (Correlations on similar attributes)

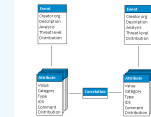

MISP - EVENT (PROPOSALS)

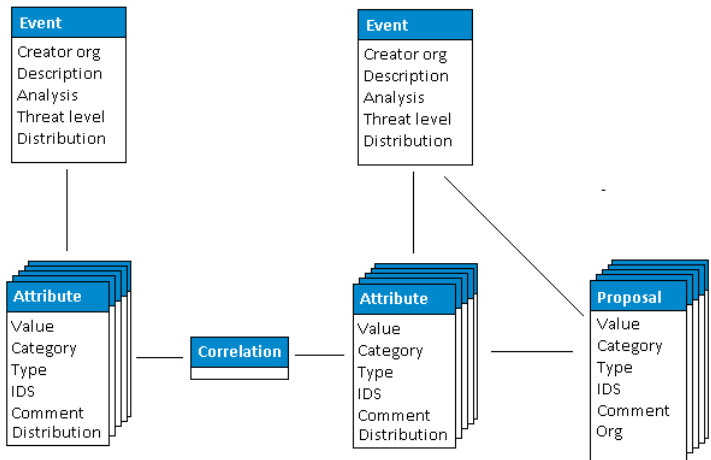

MISP - Event (Proposals)

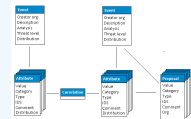

MISP - EVENT (TAGS)

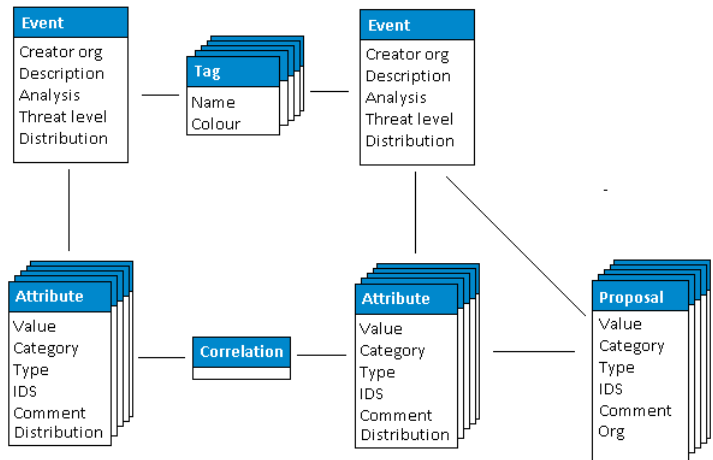

MISP - Event (Tags)

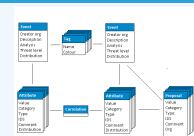

MISP - EVENT (DISCUSSIONS)

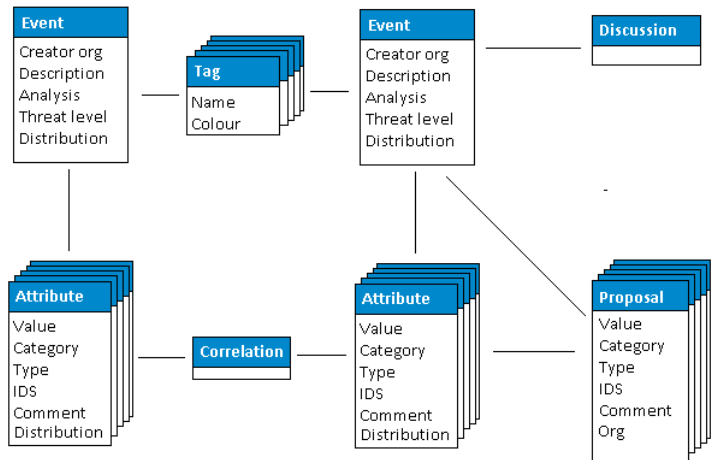

2024-07-08

MISP User Training - General usage of MISP

MISP - Event (Discussions)

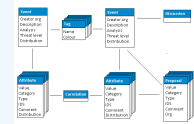

MISP - EVENT (TAXONOMIES AND PROPOSAL CORRELATIONS)

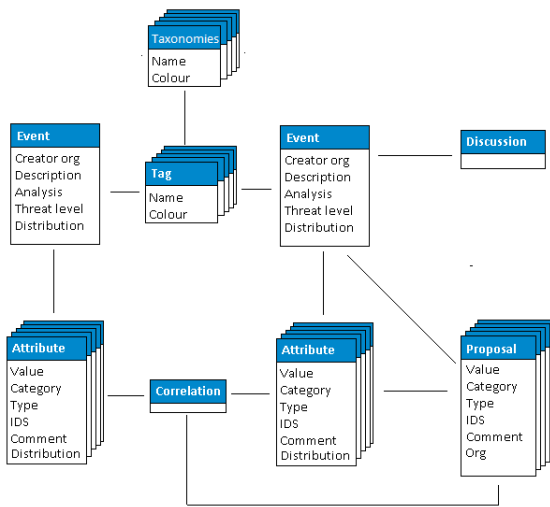

2024-07-08

MISP User Training - General usage of MISP

↳ MISP - Event (Taxonomies and proposal correlations)

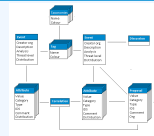

MISP - EVENT (THE STATE OF THE ART MISP DATAMODEL)

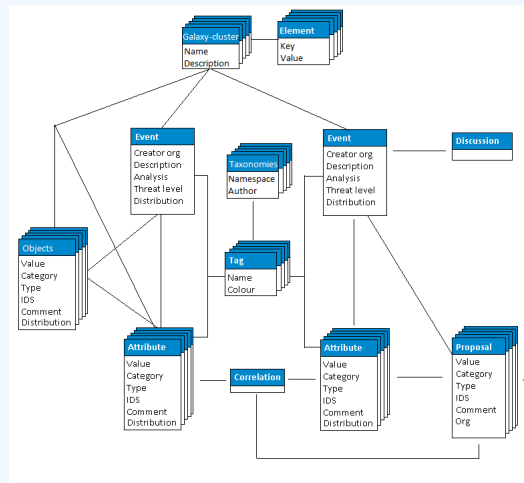

2024-07-08

MISP User Training - General usage of MISP

↳ MISP - Event (The state of the art MISP datamodel)



■ Event Index

- ▶ Event context
- ▶ Tags
- ▶ Distribution
- ▶ Correlations

■ Filters

└─ MISP - Viewing the Event Index

- Event Index
 - ▶ Event context
 - ▶ Tags
 - ▶ Distribution
 - ▶ Correlations
- Filters

■ Event View

- ▶ Event context
- ▶ Attributes
 - Category/type, IDS, Correlations
- ▶ Objects
- ▶ Galaxies
- ▶ Proposals
- ▶ Discussions

■ Tools to find what you are looking for

■ Correlation graphs

└─ MISP - Viewing an Event

- Event View
 - ▶ Event context
 - ▶ Attributes
 - Category/type, IDS, Correlations
 - ▶ Objects
 - ▶ Galaxies
 - ▶ Proposals
 - ▶ Discussions
- Tools to find what you are looking for
- Correlation graphs

■ The main tools to populate an event

- ▶ Adding attributes / batch add
- ▶ Adding objects and how the object templates work
- ▶ Freetext import
- ▶ Import
- ▶ Templates
- ▶ Adding attachments / screenshots
- ▶ API

└─ MISP - Creating and populating events in various ways (demo)

- The main tools to populate an event
 - ▶ Adding attributes / batch add
 - ▶ Adding objects and how the object templates work
 - ▶ Freetext import
 - ▶ Import
 - ▶ Templates
 - ▶ Adding attachments / screenshots
 - ▶ API

- What happens automatically when adding data?
 - ▶ Automatic correlation
 - ▶ Input modification via validation and filters (regex)
 - ▶ Tagging / Galaxy Clusters
- Various ways to publish data
 - ▶ Publish with/without e-mail
 - ▶ Publishing via the API
 - ▶ Delegation

└─ MISP - Various features while adding data

- What happens automatically when adding data?
 - ▶ Automatic correlation
 - ▶ Input modification via validation and filters (regex)
 - ▶ Tagging / Galaxy Clusters
- Various ways to publish data
 - ▶ Publish with/without e-mail
 - ▶ Publishing via the API
 - ▶ Delegation

- Correlation graphs
- Downloading the data in various formats
- API (explained later)
- Collaborating with users (proposals, discussions, emails)

└─ MISP - Using the data

- Correlation graphs
- Downloading the data in various formats
- API (explained later)
- Collaborating with users (proposals, discussions, emails)

- Sync connections
- Pull/push model
- Previewing instances
- Filtering the sync
- Connection test tool
- Cherry pick mode

└─ MISP - Sync explained (if no admin training)

- Sync connections
- Pull/push model
- Previewing instances
- Filtering the sync
- Connection test tool
- Cherry pick mode

- Feed types (MISP, Freetext, CSV)
- Adding/editing feeds
- Previewing feeds
- Local vs Network feeds

└─ MISP - Feeds explained (if no admin training)

- Feed types (MISP, Freetext, CSV)
- Adding/editing feeds
- Previewing feeds
- Local vs Network feeds

- Your Organisation Only
- This Community Only
- Connected Communities
- All Communities
- Sharing Group

└─ MISP - Distributions explained

- Your Organisation Only
- This Community Only
- Connected Communities
- All Communities
- Sharing Group

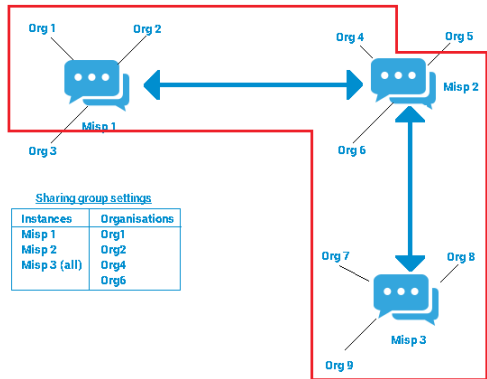

└ MISP - Distribution and Topology

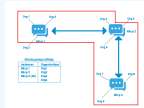

- Download an event
- Quick glance at the APIs
- Download search results
- ReST API and query builder

└─ MISP - Exports and API

- Download an event
- Quick glance at the APIs
- Download search results
- ReST API and query builder

- Settings
- Troubleshooting
- Workers
- Logs

2024-07-08

MISP User Training - General usage of MISP

└─ MISP - Shorthand admin (if no admin training)

- Settings
- Troubleshooting
- Workers
- Logs