

MISP USER TRAINING - GENERAL USAGE OF MISP

MISP - THREAT SHARING

CIRCL / TEAM MISP PROJECT

[HTTP://WWW.MISP-PROJECT.ORG/](http://www.misp-project.org/)

TWITTER: [@MISPPROJECT](https://twitter.com/MISPPROJECT)

CIISI-IE



MISP
Threat Sharing

- Credentials

- ▶ MISP admin: admin@admin.test/admin
- ▶ SSH: misp/Password1234

- Available at the following location (VirtualBox and VMWare):

- ▶ <https://www.circl.lu/misp-images/latest/>

- It is a bit broken.
 - ▶ `sudo -s`
 - ▶ `cd /var/www/MISP/`
 - ▶ `sudo pear install`
`INSTALL/dependencies/Console_CommandLine/package.xml`
 - ▶ `sudo pear install`
`INSTALL/dependencies/Crypt_GPG/package.xml`
 - ▶ `cd /usr/local/src/misp-modules`
 - ▶ `pip3 install -r REQUIREMENTS`
 - ▶ `pip3 install .`
 - ▶ `reboot`

Plan for this part of the training

- Data model
- Viewing data
- Creating data
- Co-operation
- Distribution
- Exports

MISP - EVENT (MISP'S BASIC BUILDING BLOCK)

Event
Creator org
Description
Analysis
Threat level
Distribution

MISP - EVENT (ATTRIBUTES, GIVING MEANING TO EVENTS)

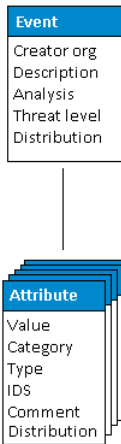

MISP - EVENT (CORRELATIONS ON SIMILAR ATTRIBUTES)

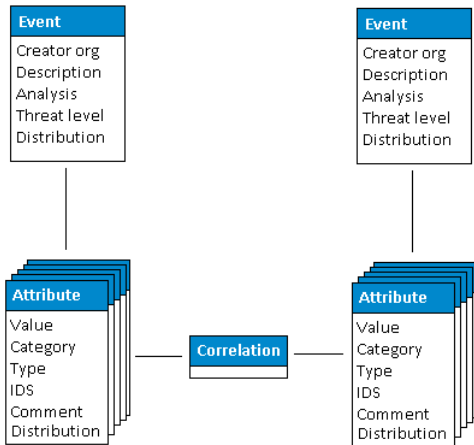

MISP - EVENT (PROPOSALS)

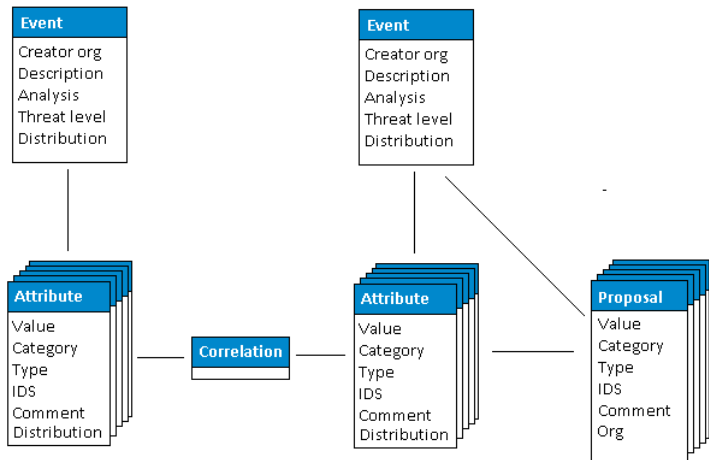

MISP - EVENT (TAGS)

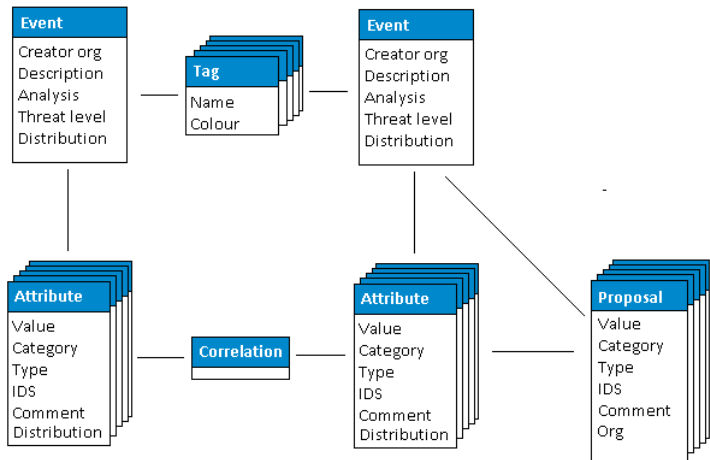

MISP - EVENT (DISCUSSIONS)

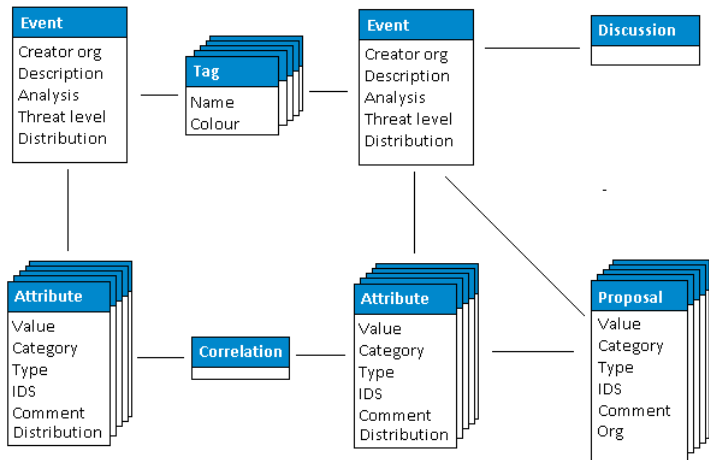

MISP - EVENT (TAXONOMIES AND PROPOSAL CORRELATIONS)

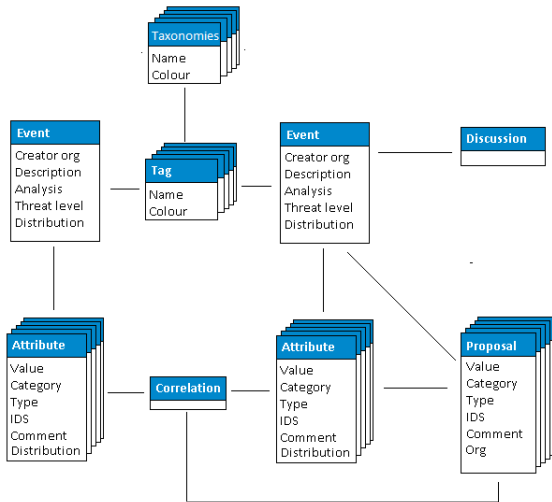

MISP - EVENT (THE STATE OF THE ART MISP DATAMODEL)

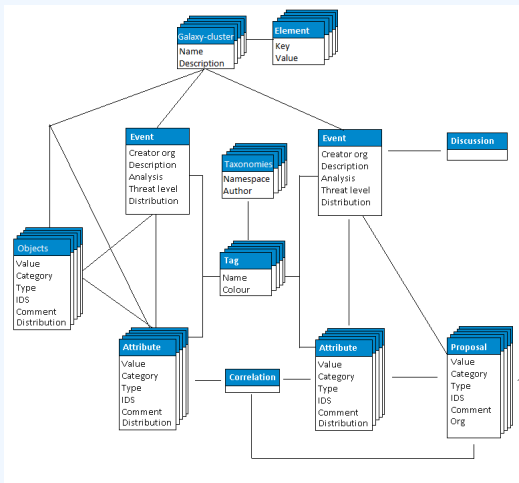

- Event Index
 - ▶ Event context
 - ▶ Tags
 - ▶ Distribution
 - ▶ Correlations
- Filters

- Event View
 - ▶ Event context
 - ▶ Attributes
 - Category/type, IDS, Correlations
 - ▶ Objects
 - ▶ Galaxies
 - ▶ Proposals
 - ▶ Discussions
- Tools to find what you are looking for
- Correlation graphs

MISP - CREATING AND POPULATING EVENTS IN VARIOUS WAYS (DEMO)

- The main tools to populate an event
 - ▶ Adding attributes / batch add
 - ▶ Adding objects and how the object templates work
 - ▶ Freetext import
 - ▶ Import
 - ▶ Templates
 - ▶ Adding attachments / screenshots
 - ▶ API

- What happens automatically when adding data?
 - ▶ Automatic correlation
 - ▶ Input modification via validation and filters (regex)
 - ▶ Tagging / Galaxy Clusters
- Various ways to publish data
 - ▶ Publish with/without e-mail
 - ▶ Publishing via the API
 - ▶ Delegation

- Correlation graphs
- Downloading the data in various formats
- API (explained later)
- Collaborating with users (proposals, discussions, emails)

- Sync connections
- Pull/push model
- Previewing instances
- Filtering the sync
- Connection test tool
- Cherry pick mode

MISP - FEEDS EXPLAINED (IF NO ADMIN TRAINING)

- Feed types (MISP, Freetext, CSV)
- Adding/editing feeds
- Previewing feeds
- Local vs Network feeds

- Your Organisation Only
- This Community Only
- Connected Communities
- All Communities
- Sharing Group

MISP - DISTRIBUTION AND TOPOLOGY

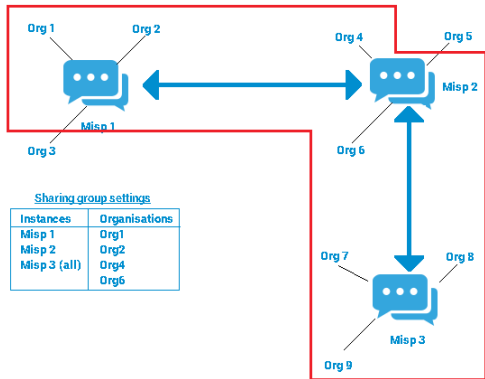

- Download an event
- Quick glance at the APIs
- Download search results
- ReST API and query builder

- Settings
- Troubleshooting
- Workers
- Logs